

Voyages of The North Cape Express

Journey mainland Norway between its capital and its capes during the mesmerizing Northern Lights seasons.

Nature runs the show

Though we always do our utmost to stick to our itinerary, the weather on the Norwegian coast sometimes has other plans.

When the water is too choppy or the fog is too thick, your safety comes first, every time. That's the case even if it means we have to change our itinerary or cancel onshore excursions at the last minute.

A word on wildlife

Just like the weather, we can't control what wildlife you get to see on your voyage with us. A lot depends on the season, migration patterns, and luck.

Nature and wildlife on the Norwegian coast are unpredictable, but really, that's what makes the surprise encounters all the more special.

A choice of two fares

Your Svalbard Express voyage aboard MS Trollfjord can be experienced on one of two fare types: Select or Suite.

1 Select

This fare offers you your choice of cabin number, full-board all-day dining with a drinks package, complimentary Wi-Fi as standard, and a possible visit to the ship's bridge. For an added touch, you can also upgrade to include premium food and drink options.

Food and drink

- Full board with all-day dining
- Drinks package (selected wine, beer, soft drinks)¹
- Complimentary water, tea, and coffee all day
- Afternoon tea and cakes in the bar

Cabins

- Choice of cabin number

On board

- Visit to the bridge⁴
- Complimentary Wi-Fi⁵

+ Upgrades

Food and drink

- + Upgrade by adding an exclusive drinks package²
- + Upgrade by adding full-board fine dining³
- + Upgrade by adding (on board only) à la carte dinner each day³
- + Upgrade by adding (on board only) use of your cabin's mini-bar
- + Upgrade by adding Norway's Coastal Kitchen welcome basket

On board

- + Upgrade by adding a seasonal clothing package⁶

2 Suite

This is the full MS Trollfjord experience. Order à la carte every day of your voyage, including in the fine dining onboard restaurant and share an intimate meal with the ship's senior officers. You'll also enjoy afternoon tea in the lounge and use of your cabin's mini-bar.

Food and drink

- Full board with all-day dining
- Drinks package (selected wine, beer, soft drinks)¹
- Complimentary water, tea, and coffee all day
- Afternoon tea and cakes in the bar
- Exclusive drinks package²
- À la carte dinner each day³
- Full-board fine dining³
- Choice of dining time³
- Exclusive dinner with senior ship officers
- Exclusive afternoon tea and cakes in the lounge
- Room-service option for breakfast from the fine dining restaurant
- All items in your cabin's mini-bar

Cabins

- Choice of cabin number
- Norway's Coastal Kitchen welcome basket
- Personal check-in service in the lounge
- Turn-down service

On board

- Visit to the bridge⁴
- Complimentary Wi-Fi
- Access to exclusive suite lounge
- Seasonal clothing package⁶
- Two optional seasonal excursions included⁶



© MIKE MAREEN - GETTY

SERVICE	SELECT	SUITE
Full board with all-day dining	●	●
Drinks package (selected wine, beer, soft drinks) ¹	●	●
Complimentary water, tea, and coffee all day	●	●
Afternoon tea and cakes in the bar	●	●
Choice of cabin number	●	●
Norway's Coastal Kitchen welcome basket	++	●
Visit to the bridge ⁴	●	●
Complimentary Wi-Fi ⁵	●	●
Exclusive drinks package ²	++	●
À la carte dinner each day ³	++	●
Full-board fine dining ³	++	●
All items in your cabin's mini-bar	+	●
Seasonal clothing package ⁶	++	●
Choice of dining time ³	+	●
Exclusive dinner with senior ship officers	-	●
Exclusive afternoon tea and cakes in the lounge	-	●
Room-service option for breakfast from the fine dining restaurant	-	●
Personal check-in service in the lounge	-	●
Turn-down service	-	●
Two optional seasonal excursions included	-	●

- (1) Only valid in the restaurants during mealtimes
- (2) Only valid in the bar after dinner, includes a wide range of drinks
- (3) Subject to availability
- (4) At the discretion of the Captain and subject to safety restrictions
- (5) Guests on Select fare will need to register on our free 1893 Ambassador loyalty program to access the Wi-Fi
- (6) Full voyage guests only, clothing items selected according to availability

●	Included
+	Upgrade possible (pre-bookable)
+	Upgrade possible (bookable onboard)
-	Not applicable

MS Trollfjord

Flagship of the Svalbard Express and the North Cape Express, MS Trollfjord takes its name from a small but spectacular fjord in the Vesterålen Archipelago. Refurbished in spring of 2023, the ship has a classic interior style with hints of nostalgic motifs sitting side by side with modern lines and design.

For relaxing

- Panoramic sauna on the top deck
- Two-story observation lounge on the upper decks
- Large outdoor sun deck with comfortable furniture and two hot tubs
- Espolin Johnson lounge for afternoon tea
- Stylish bar with a wide range of beverages
- Piano with resident and guest musicians
- Library with a selection of literature and brochures
- Onboard shop stocked with high-quality products and souvenirs
- Wi-Fi throughout the ship

For being active

- Panoramic fitness room on the top deck
- Activity center and lecture halls run by the Coastal Experience Team
- Photography area with camera equipment available for rent
- Snowshoes, fishing rods, and walking poles available for rent

For enjoying food

- Main restaurant for all three daily meals
- All-day-dining brasserie
- À la carte fine dining restaurant
- Demonstration kitchen for cooking classes and tastings

YEAR BUILT: 2002

YEAR REFURBISHED: 2023

SHIP YARD: Fosen Mek. Verk., Norway

PASSENGER CAPACITY: 566

BEDS: 542

GROSS TONNAGE: 16,140 t

LENGTH: 445.37 ft

BEAM: 70.54 ft

SPEED: 15 knots



MS Trollfjord

© FUGLEFELLET / HURTIGRUTEN

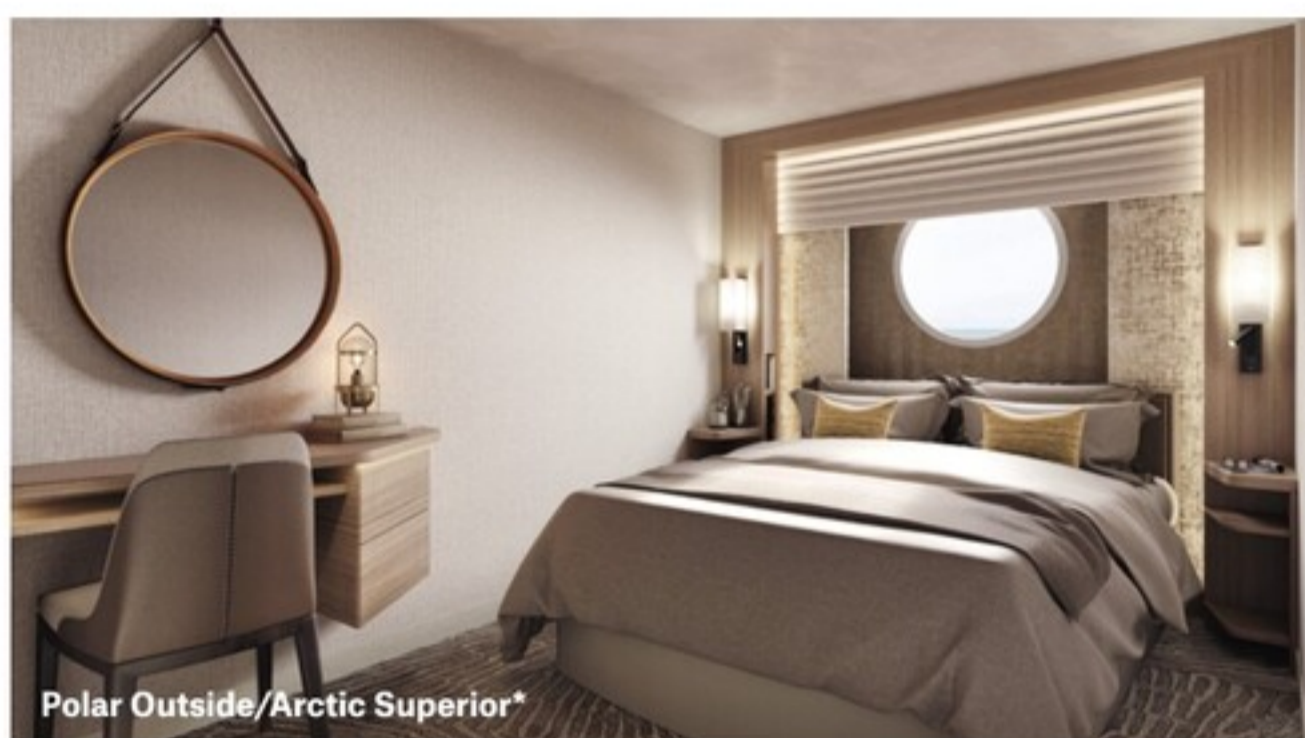

Polar Outside/Arctic Superior*

© YSA DESIGN / HURTIGRUTEN

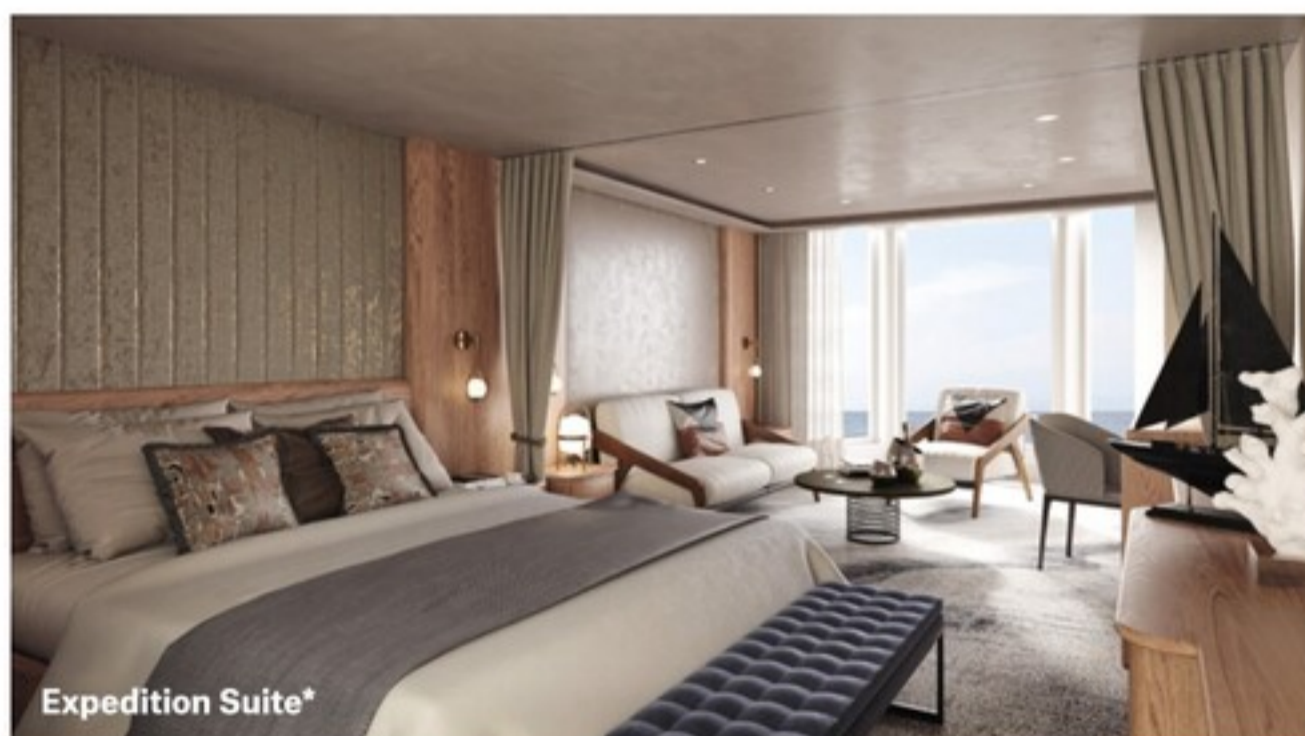

Expedition Suite*

© YSA DESIGN / HURTIGRUTEN

*Conceptual renderings only. The final design may differ.

	CATEGORY		DECK	SIZE (ft ²)	DESCRIPTION
EXPEDITION SUITES	MX	Owner's suite	9	478	Two-room suite with balcony, king bed, bathtub, seating area, dining table, mini-bar
	MG	Grand suite	8, 9	276-381	One- or two-room suite with balcony or bay window, king bed, seating area, mini-bar, some with bathtub
	M	Suite	7	252	One- or two-room suite with balcony, king bed
	Q	Mini suite	6, 7	172-252	One-room suite with king bed, seating area
ARCTIC SUPERIOR	QJ	Outside cabin	6, 7	177	Queen bed, seating area, limited/no view
	YA	Outside cabin	6	172	Queen bed, sofa bed, table, accessible for guests with limited mobility
	P	Outside cabin	6	108-117	Queen bed
	U	Outside cabin	7, 8	117-149	Queen bed, some with twin beds where one converts into a sofa, some with table
POLAR OUTSIDE	O	Outside cabin	4, 6	108-123	Queen bed or twin beds where one converts into a sofa, some with limited view
	L	Outside cabin	3, 4	123	Twin beds where one converts into a sofa, some with upper and lower berth, some with limited/no view
	J	Outside cabin	6, 7	123	Three twin beds where one converts into a sofa and one is an upper berth, limited or no view
POLAR INSIDE	I	Inside cabin	4, 6, 7	99-114	Twin beds where one converts into a sofa or upper and lower berths

All cabins have a bathroom with a shower. All information is subject to change. Cabin category J and Q: Some cabins may have an obstructed view due to lifeboats or other safety equipment.

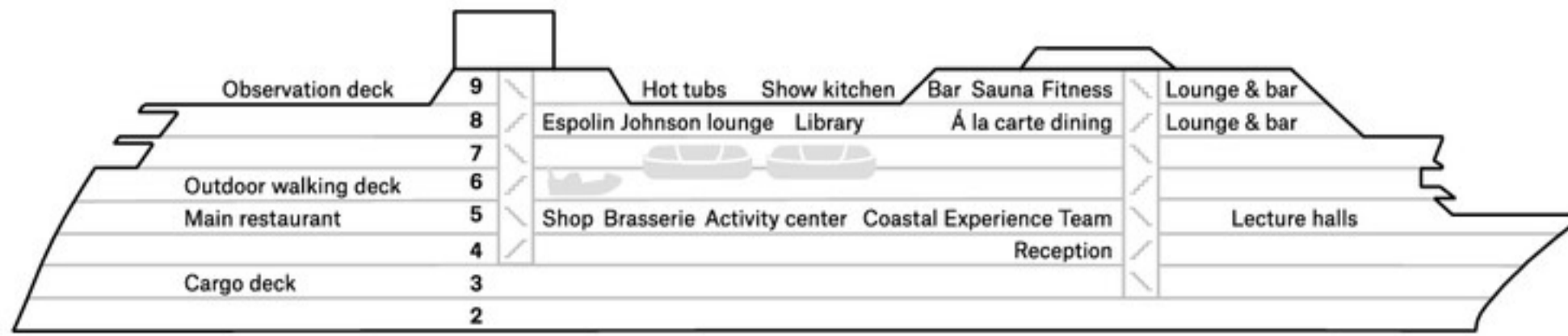

Deck

9

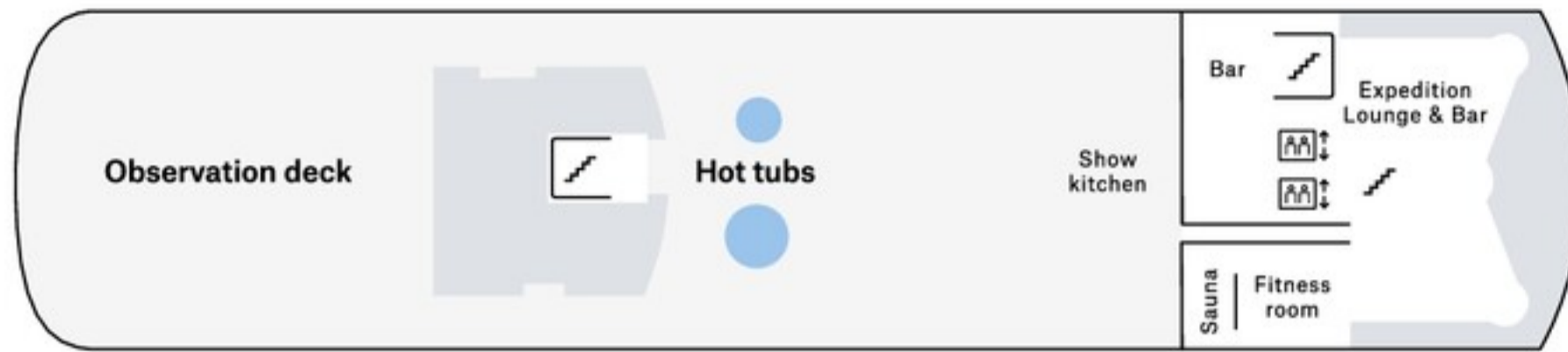

8

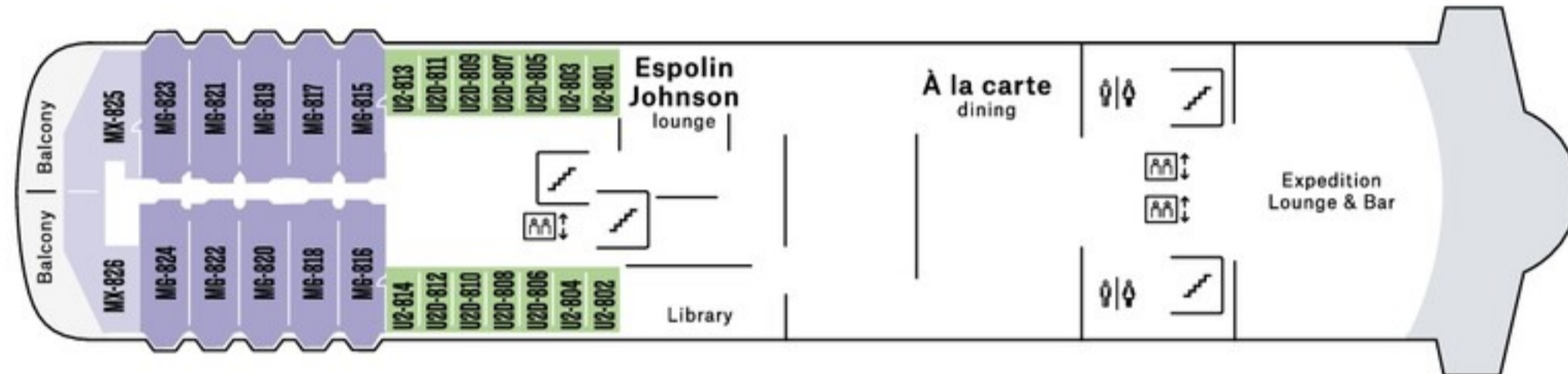

7

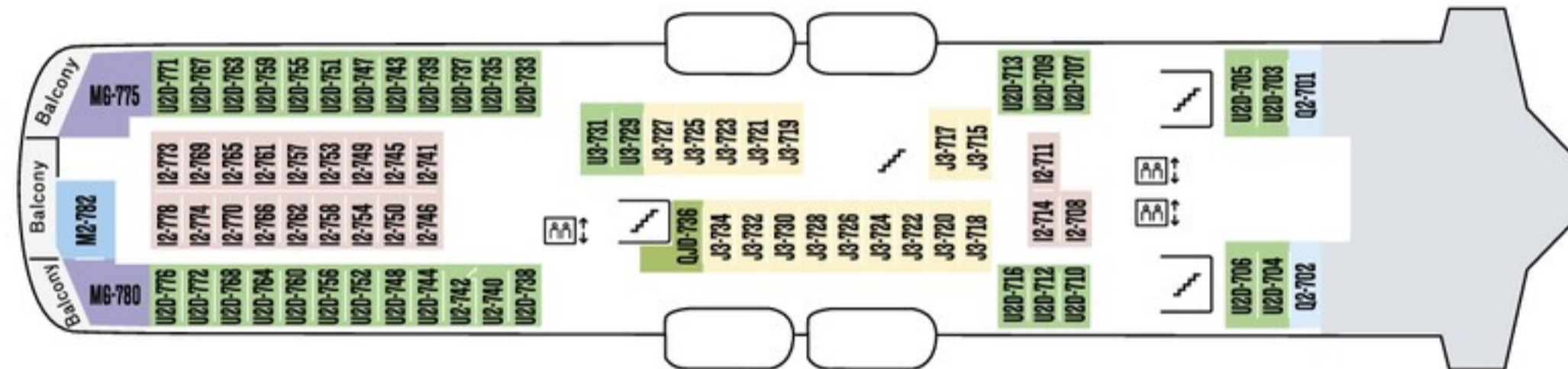

6

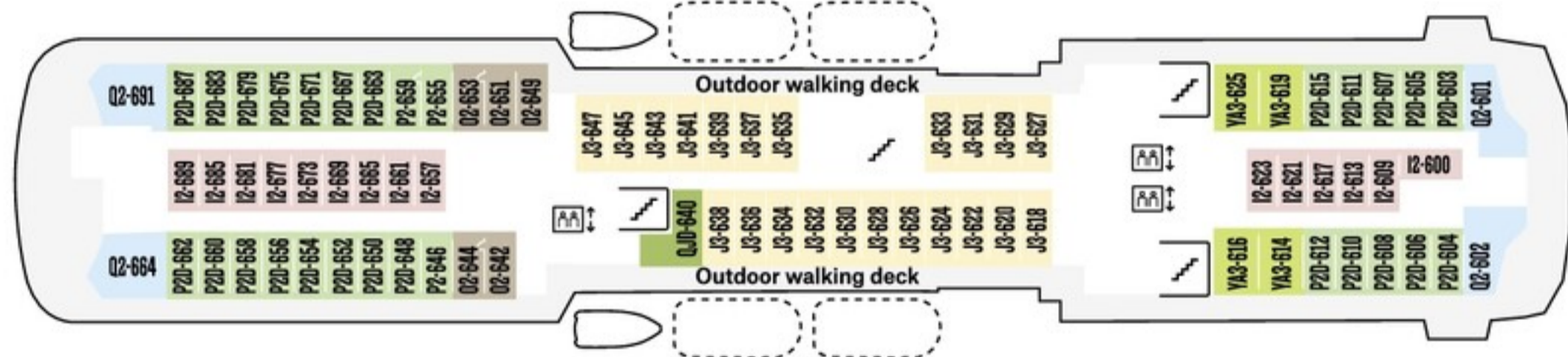

5

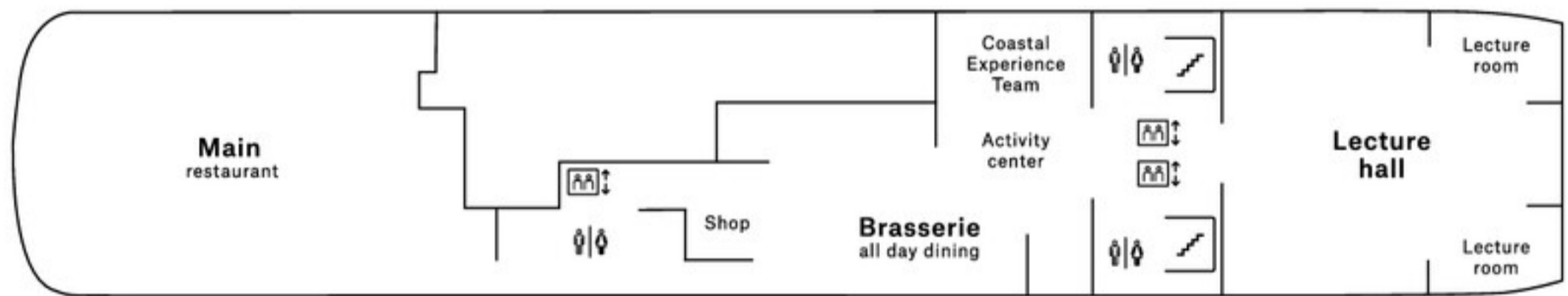

4

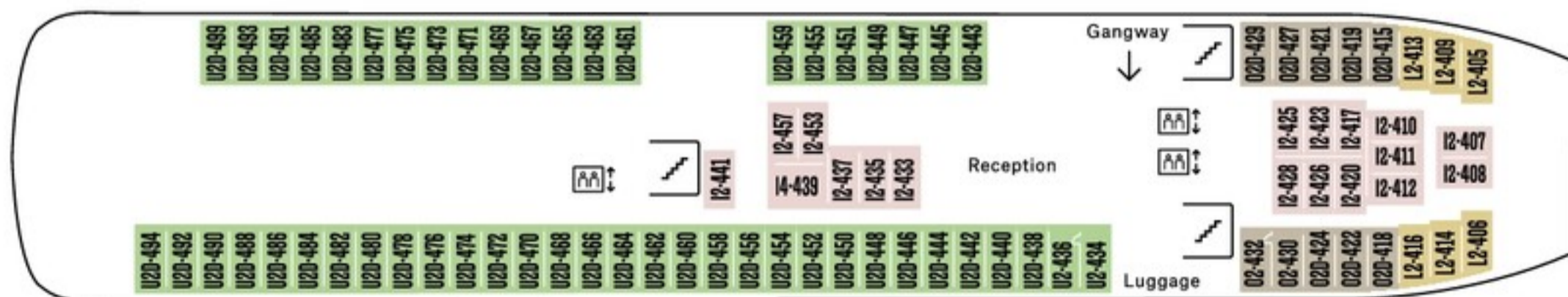

3



Welcome aboard MS Trollfjord

An iconic sailing deserves an iconic ship. Everything about MS Trollfjord is carefully designed to enhance your onboard experience, from the décor to the entertainment.

Natural nostalgia

Undergoing a complete refurbishment in spring 2023, MS Trollfjord is an homage both to Norwegian nature and to our 130-year heritage sailing the Norwegian coast. Locally sourced natural materials of wood and stone feature prominently throughout the ship's furnishings, reflecting the beauty of the fjords we sail through.

The style of décor is classic, timeless, and unique in our fleet. You'll notice details and flourishes that evoke a sense of nostalgia, harking back to a golden era of exclusive small-ship sailing.

Fitness and fabulous views

The top of the ship is Deck 9. The furnished outdoor deck here is the place to go to enjoy some fresh air while the two-story observation lounge offers unmatched views of the Norwegian coast from the bow.

You'll also find the panoramic sauna and enlarged fitness room

up on Deck 9. The floor-to-ceiling windows allow you to work up a sweat without missing the spectacular scenery.

The hub of the ship

The activity center at the heart of the ship is where your Coastal Experience Team will be busy organizing onboard activities, optional hikes, or booking you on exciting excursions. Receive photography tips from trained instructors on the Coastal Experience Team to improve your camera skills. Or join the team for an arts and crafts session to capture the scenery of the coast.

We will also be inviting local musicians on board to perform folk, classical, and other genres popular in Norway.

The activity center connects to a large lecture hall where the Coastal Experience Team will deliver thought-provoking lectures on an eclectic range of topics.





Conceptual renderings only. The final design may differ.





Timeless coastal flavors

The food experience aboard MS Trollfjord does more than sustain you. It immerses you in the produce, people, traditions, and latest innovations of Norway's Coastal Kitchen.

Connecting you to the coast through cuisine

Our chefs source the best local ingredients along our route to reimagine dishes of the past. Using short-traveled, homegrown produce, our food is fresh and flavorful, doing good for both local suppliers and nature.

Feel closer to coastal cuisine through cooking demonstrations and cabinets displaying dry-aged premium meat cuts and mouthwateringly fresh herbs that are grown on your ship. Look forward to delectable afternoon teas and evening meals inspired by the local region.

Food with heritage at its heart

To survive the hard Arctic winters, our forefathers used various age-old food preservation techniques that allowed them to keep ingredients fresher and even more flavorful for longer. Dried fish is the best example of that and, for good reason, it's high on the list as one of Norway's most popular exports.

Aboard MS Trollfjord, you'll taste how our chefs are taking inspiration from and celebrating those culinary traditions. Savor the way classic Norwegian techniques like salting, drying, smoking, curing, and pickling help to enhance local ingredients. The result are dishes bursting with distinct flavors and a touch of Nordic nostalgia.

Show kitchen

The ship has its very own show kitchen located on the top deck with large windows and a heated ceiling. There, our talented chefs take you from fjord to fork with in-depth demonstrations, such as fish filleting and curing master classes. You can also stream live sessions straight to your cabin.

These mini cooking courses are all set against a backdrop of the Norwegian landscape that produced the very ingredients we use. As we sail, you'll pass the fjords that gave us our fish, the mountains that grew our berries, and the slopes that reared our lamb.

You'll also learn about local delicacies such as seaweed and *skrei* in the show kitchen; where they come from, how to prepare them, and, of course, how they taste. And there are plenty of other delights to sample, too, from wine tasting to a flaming barbeque to traditional Norwegian *lefse* hot off the griddle.

Culinary Ambassador

Halvar Ellingsen is a top-tier head chef who lives and works on the Norwegian coast. He's bringing his specialist knowledge of short-traveled ingredients and their own individual brand of culinary flair to our menus.

Through conscientious cooking, he champions local suppliers as well as organic and sustainable ingredients to create exceptional gastronomic experiences.

The art of exquisite cuisine

Flirt with the past through immersive and nostalgic dining concepts that proudly present the finest modern Norwegian cuisine, with sustainability at its core.

Traditions with a twist

Dining on MS Trollfjord is a celebration of the best of the past, with added modern flair. We've revived the drinks carts, retro décor, traditional Norwegian food preservation techniques, and dishes that hark back to the first time we sailed this route to present you with an exquisitely nostalgic dining experience.

Whether it's breakfast, lunch, afternoon tea, or dinner, you'll find some of Norway's most cherished coastal dishes on menus that makes the most of seasonal, local produce. And there's no better way to end your culinary experience than indulging in the gala dinner on the last night of your voyage.

All-day dining

In the mood for hearty, traditional food bursting with local ingredients and flavors? Head to the bistro for all-day dining. With a relaxed and rustic ambience, you'll find cabinets showcasing dry-aged fish, meat, and herbs we've grown on board.

Eat to your heart's content with retro favorites like whole roasted *kye* legs (kid goat) or Arctic char from Finnmark. And if you'd prefer to grab and go, there are a range of satisfying takeaway sandwiches and burgers that you can eat where you please.

Fine dining

Savor a sublime à la carte experience in our fine dining restaurant where we've harnessed top-quality local, seasonal ingredients to present you with the finest flavors of the Norwegian coast.

Craft your own multi-course meal from the wide selection of dishes on offer, including recipes born from the gastro-genius of our Culinary Ambassador, award-winning local Head Chef Halvar Ellingsen.

On the menu, you'll find succulent meat dishes, such as reindeer tenderloin, but this is first and foremost a seafood restaurant. Treat yourself to hand-plucked scallops, flaky, melt-in-your-mouth Arctic

char, freshly caught oysters, and juicy crayfish. Seaweed and kelp also feature across many of our dishes as they're sustainable, nutritious, and packed with flavor.

To complement the unmistakable sweetness of the sea, we serve some of the freshest Norwegian herbs, vegetables, and flora plucked straight from the mountains, valleys, and forests. Our resident sommeliers are also on hand to help pair the perfect wine with each dish.

Panorama bar

You can also relish local beverages and afternoon tea in the bar. Situated in MS Trollfjord's two-story observation deck, it's a great place to unwind and marvel at the outstanding views. You'll find signature cocktails made with berries picked along the coast, beer brewed with water from Trollfjord, gin crafted in the clear fjords of Troms, and a wide selection of Norwegian aquavit.





Sleeping in style

Whether you want to take in the ocean views from your bed or enjoy a good book in your cozy seating area, you'll find the perfect place to lay your head among our four comfortable cabin styles.

On MS Trollfjord, picking one of our Polar Outside or Arctic Superior cabins, or an Expedition Suite, grants you the precious luxury of being able to gaze out your window at the majestic Norwegian coast while still cuddled up in the comfort of your cabin. Each cabin has individual specifications.

Expedition Suite

Luxurious, spacious, stylish, these suites are the finest on the ship and are all located on the upper deck for views to match. They feature seating areas with a TV, an espresso machine, a mini-bar loaded with goodies, ensuite bathrooms, and soft, king-size beds.

Arctic Superior

Pure comfort is the hallmark of these cabins. Situated on almost every deck, they all have ensuite bathrooms with a shower, a TV, a mini-bar, and complimentary teas and coffees. Most of the cabins have queen beds and some have twin beds.

Polar Outside

Our Polar Outside cabins are mostly on the lower decks. All have ensuite bathrooms with a shower. Most feature a window or small porthole for exterior views. Some views may be blocked by lifeboats and others may look out onto the mid-level walking deck.

Polar Inside

These are similar in size to Polar Outside cabins, just without the window. Cabins may have twin beds, one of which converts into a sofa, or upper and lower berths with one bed above the other for a traditional sailing experience.





Conceptual renderings only. The final design may differ.



Conceptual renderings only. The final design may differ.



Your Coastal Experience Team

Meet your enthusiastic Coastal Experience Team, dedicated to helping you get the most out of your voyage. More than just guides, these experts are by your side throughout the voyage, getting to know you, tailoring their recommendations to you, and sharing their stories with you.

No guidebook, website, or mobile app can replace the human connection of having our Coastal Experience Team members point out places on the coast special to them. Through their hands-on experience of Norway and the Norwegian coast, you'll be able to learn insights and key facts about the landscapes, culture, and way of life here.

From near and far

Coastal Experience Team members might be local Norwegians, born and raised on the coast and elsewhere in Norway. They'll be able to tell you their childhood memories of our ships, what our service has meant to their coastal community, and maybe how they've had generations of their family connected to us, either as crew or as passengers.

Other Coastal Experience Team members may have lived in Norway for several years, perhaps coming from the same country as you. You can learn about what drew them to Norway

and to working with The Coastal Express. See the coast through their eyes as they pick out details about life here, perhaps sharing interesting anecdotes about their experiences of Norwegian culture.

Enriching your experience

The Coastal Experience Team enhances your voyage with in-depth knowledge of the local culture, nature, science, and history; an understanding they've treasured up over years. You'll see that they have a range of specialist, well-researched topics in their repertoire, ready to share with you in lectures and presentations on board. The team is more involved in your experience than ever before. They get to know you right from the start so they can effectively tailor your trip to your interests. They're here to guide you through the whole process, from helping you pick the perfect excursions for you to leading you on onshore activities.

Keen photographers will be pleased to know that the Coastal Experience Team also conducts a small photography program on board. Certified by Canon, the short, informal course is designed to give you the tips you need to capture the coast in all its glory, including how to shoot the Midnight Sun in Arctic Norway and in Svalbard.

Dedicated to what they do and to the Norwegian coast, the Coastal Experience Team members provide an intimate and personal perspective to your journey with us. You'll sense their passion whether they're busy talking about points of interest out on deck or animatedly telling stories over a relaxed drink at evening gatherings.



HURTIGRUTEN EXPEDITIONS
1505 Westlake Ave. N., Suite 125
Seattle WA 98109

FOR RESERVATIONS
CALL (866) 552-0371 U.S. / (800) 323-7436 Canada
BOOK ONLINE AT HURTIGRUTEN.COM
EMAIL US AT usbooking@hurtigruten.com
CONTACT YOUR TRAVEL ADVISOR

Follow us on Facebook, Twitter & Instagram

